

Meet the Avion Flagship 5th Wheel

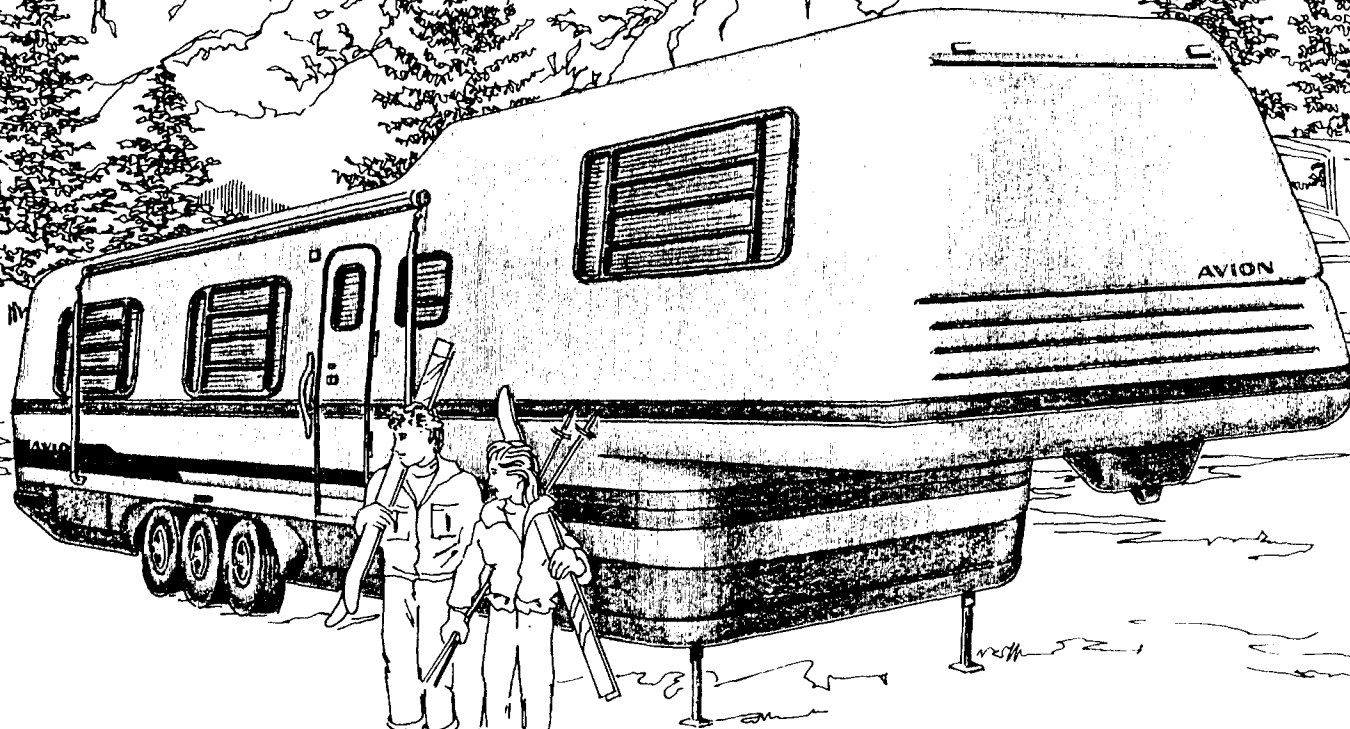

AVION

Unexcelled for Luxury & Convenience

Meet Avion's unexcelled 5th wheel trailer. This model combines aircraft-style aerodynamics and construction with residential features for the full timer or long-term vacationing family.

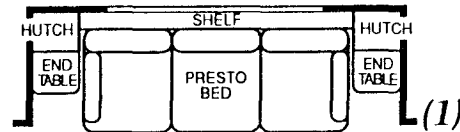
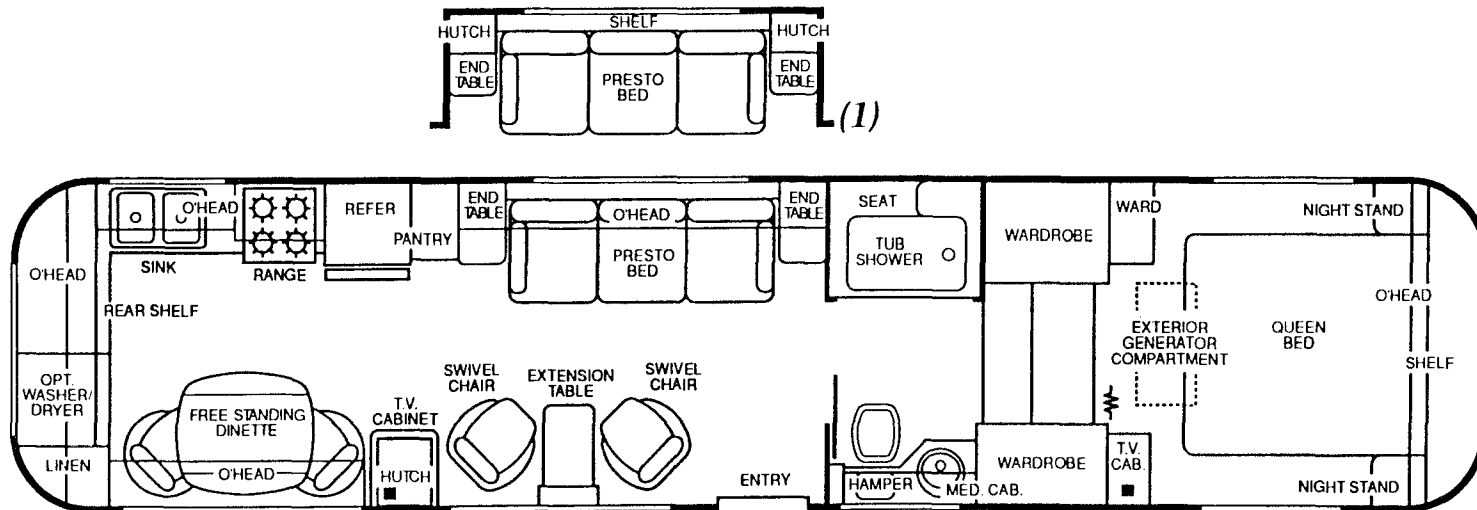

38 5M

Avion's 5th wheel offers total elegance throughout. HIGHLIGHTS — free-standing dinette for seating and room arrangement choice, four distinct living areas. This model is equipped with basement storage. Options (1) power slide out (2) twin beds.

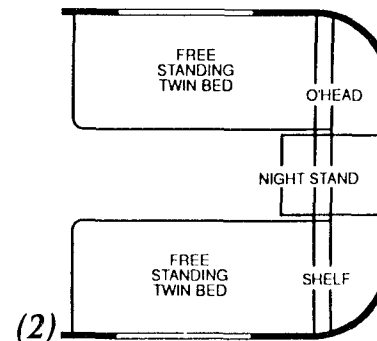

Avion 5th Wheel Specifications & Equipment

	38 5M
Weights, Measures	
Length	38'2"
Width	7'11"
Height (including roof air)	11'9"
GVWR — lbs.	14,000
Gross dry weight — lbs.	9365
Hitch dry weight — lbs.	2050
Radial Tires	•
Seating/Sleeping (Standard)	
Sleeping capacity	4
Queen bed size — Sealy®	60x80
Presto Bed Size 46x76®	•
Galley	
Refer w/2-way LP/110V (size)	Lge.
Range — DLX 4 burner w/lge. oven & light	•
Electronic Touch Control Microwave Oven w/Browning	•
Range hood (power)	•
Sink — porcelain 18" x 32"	•
Single lever faucet	•
Galley top — laminate w/self edge	•
Water filter	•
Sink cover — hardwood (2)	•
Galley window w/mini blind	•
Spice cabinet	•
Pull-out towel bar	•
Spice rack (2)	•
Range cover — stainless steel	•
Bath	
Tub with seat	•
Large oval sink	•
Telephone shower head	•
Brass finished hardware	•
Marine toilet (w/water saver)	•
Lighted medicine cabinet	•
Mirrored wardrobe doors	•

	38 5M
Bath (Cont'd.)	
Towel bar and ring	•
Bath window w/mini blind	•
Hamper w/removable laundry bag	•
Folding Tub Enclosure	•
Storage	
Pantry (slide-out)	•
Raised panel solid oak doors	•
Hinges w/struts (overhead)	•
Positive catches	•
Wooden drawers w/Accuride slides and friction travel lock	•
Dovetail drawer construction	•
Cedar lined wards	•
Wardrobe w/shelf	•
Below floor storage (exterior)	•
Basement storage (exterior)	•
Presto Bed Storage	•
Electrical	
Dual 12V battery container	•
50 amp power center — 110V/12V w/conv.	•
Utility compartment 110V outlet	•
30' heavy duty 110V shore line	•
Switch controlled lighting	•
Monitor panel	•
Walkway night lights	•
Decorative lights — wall mount 12V	•
Braund T.V. antenna**	•
Park cable TV hookup	•
AM/FM stereo w/4 two-way speakers	•
Back-up lights	•
12V porch light	•
12V interior entry light	•
Ward lights	•
Telephone jack (LR, BR)	•
12V Kill Switch	•

	38 5M
Water/Drain System	
Fresh water capacity (gals.)	70
Waste water capacity (gals.)	55
Grey water capacity (gals.)	55
12V demand water system	•
Electronic ignition water heater (gallons)	10
Water tank by-pass fill	•
Adjustable water regulator	•
Galley faucet w/hand sprayer	•
Heating/Ventilation	
Ducted furnace w/thermostat (BTU)	25M (2)
Radius torque windows — tinted safety glass	•
Hammond® power roof vents — 2-speed (3 ea.)	•
13.5M BTU Roof A/C w/heat strip	•
Safety	
Fire extinguisher	•
GFI protection	•
Emergency egress	•
Smoke detector	•
LPG leak detector	•
Center stop light	•
Radius corner countertops	•
Dead bolt lock	•
Flush door latch	•
Lighted entry assist handle	•
Interior	
Heavy vinyl walls	•
5' Dacron wrapped cushions	•
Lined drapery w/mini blind	•
Drapery valances	•
Carpet	•
All wood cabinets	•
Wall Clock	•

	38 5M
Interior (Cont'd.)	
Free standing chair (qty)	2
Bedsprads & pillow shams	•
Exterior	
Dura-Brite® aluminum skin	•
AL-KO® suspension	•
Heavy duty rear bumper	•
"Mod" wheels w/trim rings	•
"Thermo-X" insulation	•
Electric brakes — all wheels	•
Insulated sandwich subfloor	•
Stabilizing jacks (rear)	•
12V power jacks (front)	•
Power Box Stabilizer Jack	•
Dual LPG tanks w/sight gauge (80 lbs.)	•
Open truss	•
**Jacks in bedroom and living room.	

Options

	38 5M
021 Side awning	•
022 Window awning	•
032 Hitch assy. w/frame mounting kit	•
121 Conv. microwave w/cooktop	•
126 Washer/dryer	•
137 10 gal. 110V DSI water heater	•
236 Dual A/C 13.5M	•
320 Gen. ready 4.0KW Onan	•
325 Gen., 4.0KW Onan	•
618 Storm windows	•
839 Free standing twin beds — Sealy®	•
965 Power slide-out	•

Option availability is subject to change without notice.

Prices and specifications are subject to change without notice. Selected decorator items shown in the photographs are not part of the product unless specified. All fuel and liquid capacities are approximate and dimensions are nominal.

Avion Hidden Features

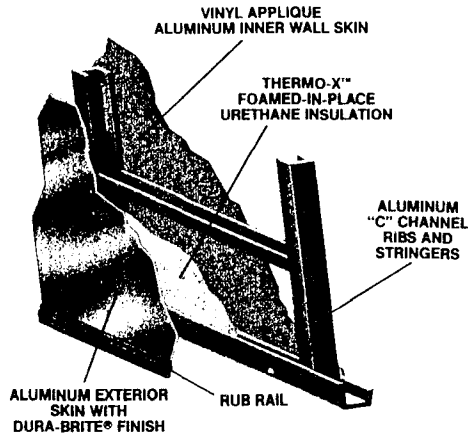

Wall Construction

In line with traditional aircraft construction, Avion's inner aluminum wall and outer aluminum skin is supported by aluminum ribs and stringers. The Thermo-X™ insulation is foamed in place and creates uniform thermal and sound insulation throughout. New Dura-Brite® exterior offers easy maintenance and superior finish.

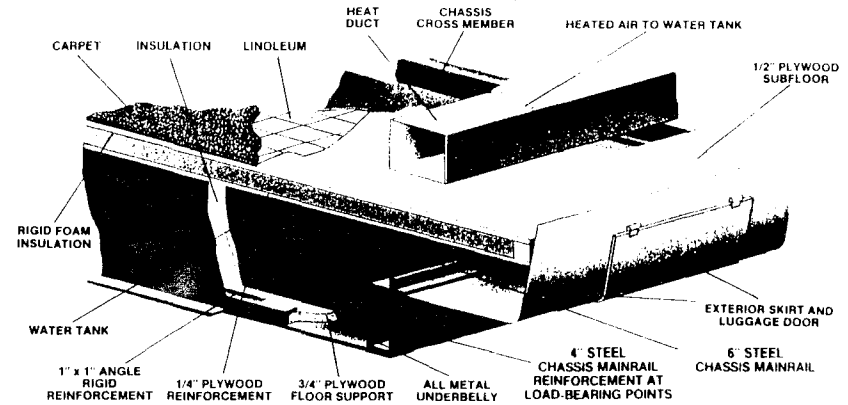

Floor Construction

Floor construction assures the strength, durability, and convenience you expect from Avion. All water and plumbing lines are contained within the floor and protected by the full length all metal underbelly. Basement floor construction differs somewhat.

AL-KO® Suspension

Tested on Europe's Auto Bahn, AL-KO® suspension provides incredibly smooth towing and handling — for your safety and protection of on-board personal goods.

Fully independent suspension • Patented hexagonal design for maximum shock absorption • Safe, smooth, quiet ride • Maintenance free, no metal to metal contact • Faster, easier installation • Lower center of gravity, improved stability • Capacities from 500 to 7,000 pounds • Manufactured in U.S.A.

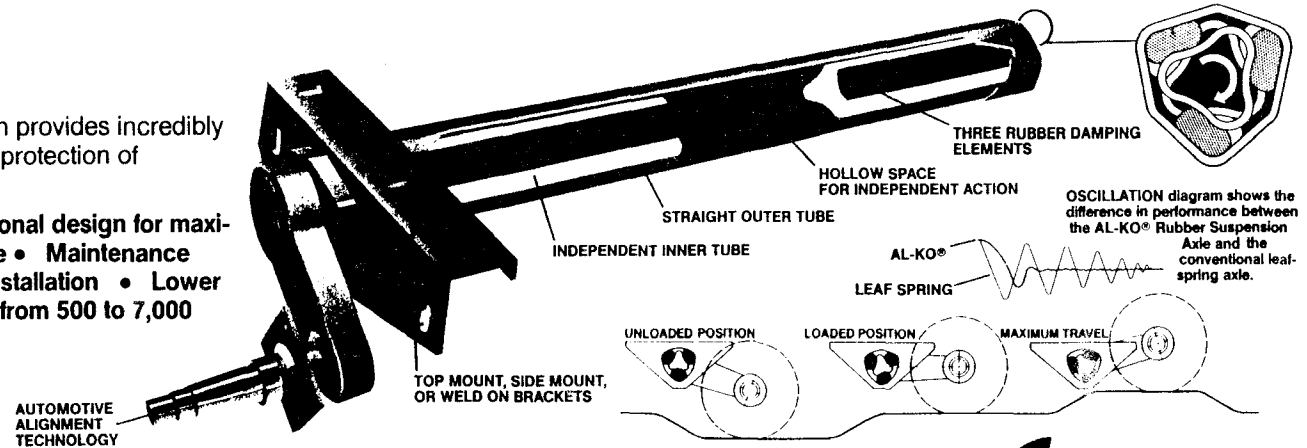

Avion Travel Trailers are manufactured by this subsidiary of Fleetwood Enterprises, Inc.

Avion Coach Corporation

1300 E. Empire Avenue

Benton Harbor, Michigan 49022

Your Local Avion Dealer Is:



AVION

FLEETWOOD®

FLEETWOOD ENTERPRISES, INC.

P.O. Box 7638

Riverside, California 92523

If It's Built By Fleetwood, It's Built For Fun!